

Parts List				
ITEM	DESCRIPTION	PART NO.	QTY	NOTES
1	BOOT, RIBBON, UNIVERSAL, MTP®	19676	1	
2	SPRING PUSH, UNIVERSAL, OVAL & RIBBON, MTP®	5551	1	
3	SPRING, UNIVERSAL, 9.8N, MTP®	17167	1	
4	PIN CLAMP or PIN SPACER	SEE KIT TABLE COLUMN A	1	NOTE 1
5	ASSEMBLY, HOUSING, MTP®	SEE KIT TABLE COLUMN B	1	
6	DUST CAP, MTP®	17242	1	

NOTES:
 1. MALE CONNECTOR KIT HAS PIN CLAMP ASSEMBLY.
 FEMALE CONNECTOR KIT HAS FEMALE PIN SPACER.

KIT P/N	KIT DESCRIPTION	PERFORMANCE	COLUMN A			COLUMN B		
			PIN CLAMP/SPACER P/N	HSG ASSY P/N	HSG ASSY COLOR	PIN CLAMP/SPACER P/N	HSG ASSY P/N	HSG ASSY COLOR
19975	KIT, MTP®, UNIVERSAL, FEMALE, MM, RIBBON, BEIGE	MM	17795	MTP-A12-11	BEIGE			
19976	KIT, MTP®, UNIVERSAL, MALE, MM, RIBBON, BEIGE	MM	17799	MTP-A12-11	BEIGE			
19977	KIT, MTP®, UNIVERSAL, FEMALE, MM, RIBBON, BLACK	MM	17795	MTP-A12-02	BLACK			
19978	KIT, MTP®, UNIVERSAL, MALE, MM, RIBBON, BLACK	MM	17799	MTP-A12-02	BLACK			
19979	KIT, MTP®, UNIVERSAL, FEMALE, MM, RIBBON, AQUA	MM or MM MTP Elite®	17795	7871	AQUA			
19980	KIT, MTP®, UNIVERSAL, MALE, MM, RIBBON, AQUA	MM	17799	7871	AQUA			
19981	KIT, MTP®, UNIVERSAL, MALE, MM MTP Elite®, RIBBON, AQUA	MM MTP Elite®	17800	7871	AQUA			
19982	KIT, MTP®, UNIVERSAL, FEMALE, MM, RIBBON, MAGENTA	MM or MM MTP Elite®	17795	13949	MAGENTA			
19983	KIT, MTP®, UNIVERSAL, MALE, MM, RIBBON, MAGENTA	MM	17799	13949	MAGENTA			
19984	KIT, MTP®, UNIVERSAL, MALE, MM MTP Elite®, RIBBON, MAGENTA	MM MTP Elite®	17800	13949	MAGENTA			
19985	KIT, MTP®, UNIVERSAL, FEMALE, MM, RIBBON, HEATHER VIOLET	MM or MM MTP Elite®	17795	16693	HEATHER VIOLET			
19986	KIT, MTP®, UNIVERSAL, MALE, MM, RIBBON, HEATHER VIOLET	MM	17799	16693	HEATHER VIOLET			
19987	KIT, MTP®, UNIVERSAL, MALE, MM MTP Elite®, RIBBON, HEATHER VIOLET	MM MTP Elite®	17800	16693	HEATHER VIOLET			
19988	KIT, MTP®, UNIVERSAL, FEMALE, MM, RIBBON, MUNSSELL VIOLET	MM or MM MTP Elite®	17795	16791	MUNSSELL VIOLET			
19989	KIT, MTP®, UNIVERSAL, MALE, MM, RIBBON, MUNSSELL VIOLET	MM	17799	16791	MUNSSELL VIOLET			
19990	KIT, MTP®, UNIVERSAL, MALE, MM MTP Elite®, RIBBON, MUNSSELL VIOLET	MM MTP Elite®	17800	16791	MUNSSELL VIOLET			
19991	KIT, MTP®, UNIVERSAL, FEMALE, MM, RIBBON, LIME	MM or MM MTP Elite®	17795	18829	LIME			
19992	KIT, MTP®, UNIVERSAL, MALE, MM, RIBBON, LIME	MM	17799	18829	LIME			
19993	KIT, MTP®, UNIVERSAL, MALE, MM MTP Elite®, RIBBON, LIME	MM MTP Elite®	17800	18829	LIME			
19994	KIT, MTP®, UNIVERSAL, FEMALE, SM, RIBBON, GREEN	SM	17795	16007	GREEN			
19995	KIT, MTP®, UNIVERSAL, MALE, SM, RIBBON, GREEN	SM	17800	16007	GREEN			
19996	KIT, MTP®, UNIVERSAL, FEMALE, SM MTP Elite®, RIBBON, YELLOW	SM MTP Elite®	17795	16918	YELLOW			
19997	KIT, MTP®, UNIVERSAL, MALE, SM MTP Elite®, RIBBON, YELLOW	SM MTP Elite®	17801	16918	YELLOW			
21549	KIT, MTP®, UNIVERSAL, MALE, SM MTP Elite®, RIBBON, GREEN	SM MTP Elite®	17801	16007	GREEN			

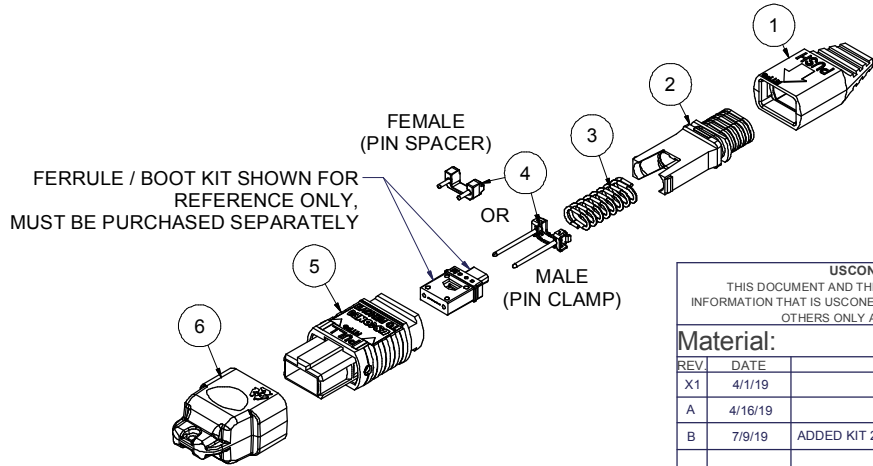

USCONEC LTD. PROPRIETARY
 THIS DOCUMENT AND THE ASSOCIATED DATA CONTAIN RESTRICTED INFORMATION THAT IS USCONEC LTD. PROPERTY. DISCLOSE OR DUPLICATE FOR OTHERS ONLY AS AUTHORIZED BY USCONEC LTD.

Material:

REV	DATE	DESCRIPTION	ECN
X1	4/1/19	---	
A	4/16/19	INITIAL RELEASE	2206-mm
B	7/9/19	ADDED KIT 21549 (SME W/ GREEN HSG) TO TABLE	

CUSTOMER DRAWING

DIMENSIONS FOR REFERENCE ONLY

THIRD ANGLE PROJECTION

METRIC/mm

USCONEC Hickory, NC
 800-769-0944
www.usconec.com

TITLE
 KIT, MTP® CONNECTOR, UNIVERSAL, RIBBON

SIZE S&M Part No.: SEE TABLE DWG NO. **C19975** REV B

SCALE N.T.S. Drafter M.McCROSKEY Date: 4/1/2019 SHEET 1 OF 2

▲ DENOTES CRITICAL DIMENSION

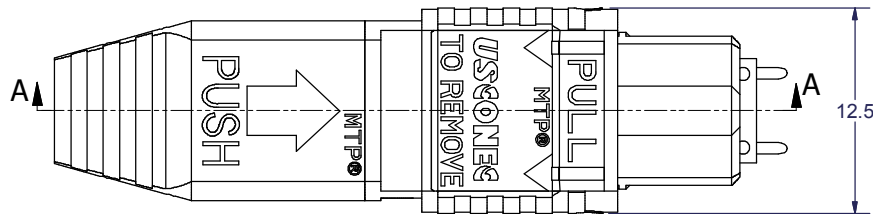
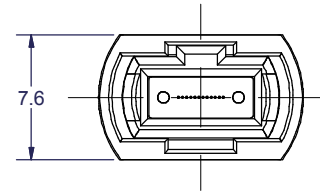
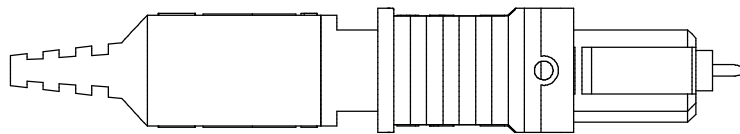

12.5

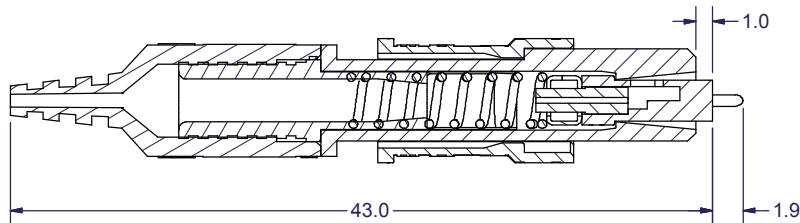

SECTION A-A

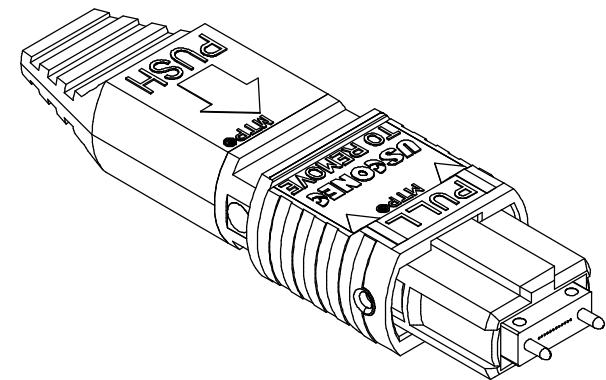

USCONEC LTD. PROPRIETARY
THIS DOCUMENT AND THE ASSOCIATED DATA CONTAIN RESTRICTED INFORMATION THAT IS USCONEC LTD. PROPERTY. DISCLOSE OR DUPLICATE FOR OTHERS ONLY AS AUTHORIZED BY USCONEC LTD.

Material:

REV	DATE	DESCRIPTION	ECN

CUSTOMER DRAWING

DIMENSIONS FOR REFERENCE ONLY

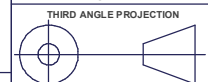

METRIC/mm



Hickory, NC
800-769-0944
www.usconec.com

TITLE
KIT, MTP® CONNECTOR, UNIVERSAL, RIBBON

SIZE	S&M Part No.:	DWG NO.	REV
B	SEE TABLE	C19975	B
SCALE	Drafter	Date:	SHEET
N.T.S.	M. McCROSKEY	4/1/2019	2 OF 2

▲ DENOTES CRITICAL DIMENSION